

J.L.Fisher

Motion Picture &  
Television Equipment

# MODEL 11 CAMERA DOLLY

OUR MOST COMPACT HYDRAULIC LIFT DOLLY

The Model 11 is our smallest Dolly. Lightweight and compact, it is built with the same high quality standards found in all J.L. Fisher products. The Model 11 Dolly shares the same controls and characteristics of the Model 10 Dolly and has a complete line of its own accessories. It operates effortlessly on Square or Round Track, making the Model 11 and Model 10 an excellent two dolly combination.

200 LB (91kg) LIFT BEAM CAPACITY



*The Model 11 Dolly is engineered and manufactured to meet the demanding production needs of the motion picture, television and video industries. Compact size, three-way steering and a solid lift beam give operators a wide variety of options. The reliable, quiet, smooth and safe Model 11 requires minimal maintenance.*

STEERING MODES

REAR (CONVENTIONAL): Front wheels are locked, rear wheels can rotate 360°.

CRAB: Front and rear wheels can rotate in unison 360°.

ROUND: Front and rear wheels rotate independently with mechanical compensation to allow variable radius turns, even down to 0 radius.

NARROW: Front and rear wheels can rotate 180° in any steering mode, providing a narrower wheel track for working in tight spaces.

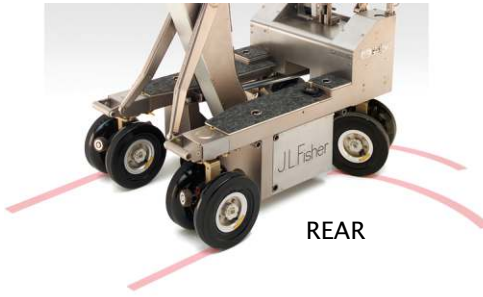

REAR

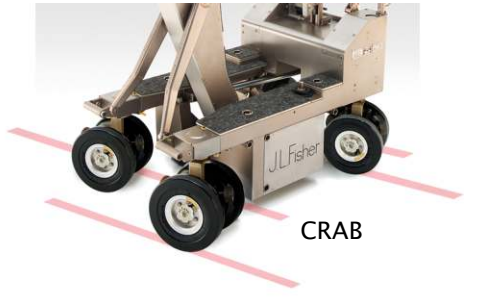

CRAB

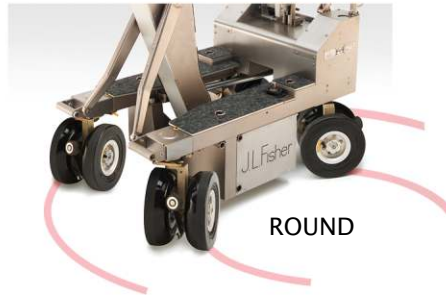

ROUND

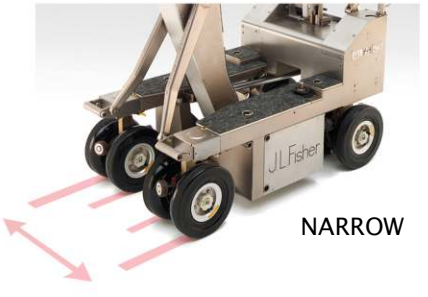

NARROW

ACCEPTS 90 TO 240 VOLTS AC OR DC TO CHARGE THE HYDRAULIC LIFT SYSTEM IN AS LITTLE AS THREE MINUTES

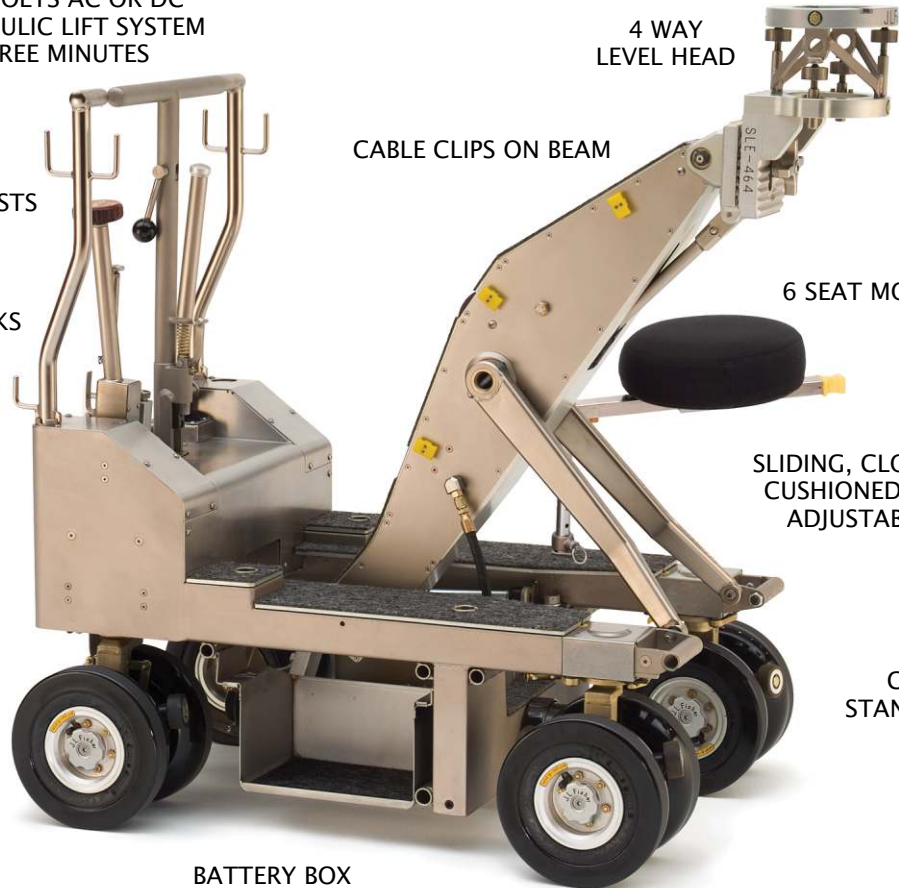

4 WAY LEVEL HEAD

CABLE CLIPS ON BEAM

6 SEAT MOUNT LOCATIONS

SLIDING, CLOTH COVERED CUSHIONED SEATS WITH ADJUSTABLE HEIGHT

CARPETED STANDING AREAS

BATTERY BOX

SINGLE LEVER POSITIVE LOCKING BRAKE SYSTEM

UTILITY HOOKS

REMOVABLE PUSH POSTS

SELF-CONTAINED TRACK GUIDE SYSTEM



PUSH POSTS DOUBLE AS REAR CARRY HANDLES



POSITIVE LOCKING BRAKES



BUILT-IN TRACK GUIDES (Square Track Only)





MITCHELL MOUNT LEVELING HEAD WITH 4 WAY ADJUSTMENT AND 360° ADJUSTABLE DIAMOND PLATE



NEW CUE BOX WITH VARIABLE LIFT RATE MEMORY STOPS AND ADJUSTABLE DRAG KNOB



LEVELING HEAD CAN BE REVERSED



SELF CENTERING HYDRAULIC LIFT BEAM CONTROL KNOB WITH SAFETY LOCK

SEVEN LIFTS PER SYSTEM CHARGE

SELF-BLEEDING HYDRAULIC SYSTEM

200 lb (91kg) LIFT BEAM CAPACITY

LIFT BEAM POSITION (CUE) INDICATOR

SELF-DAMPENING LIFT BEAM SYSTEM



OPTIONAL UP/DOWN LEVER WITH SAFETY LOCK

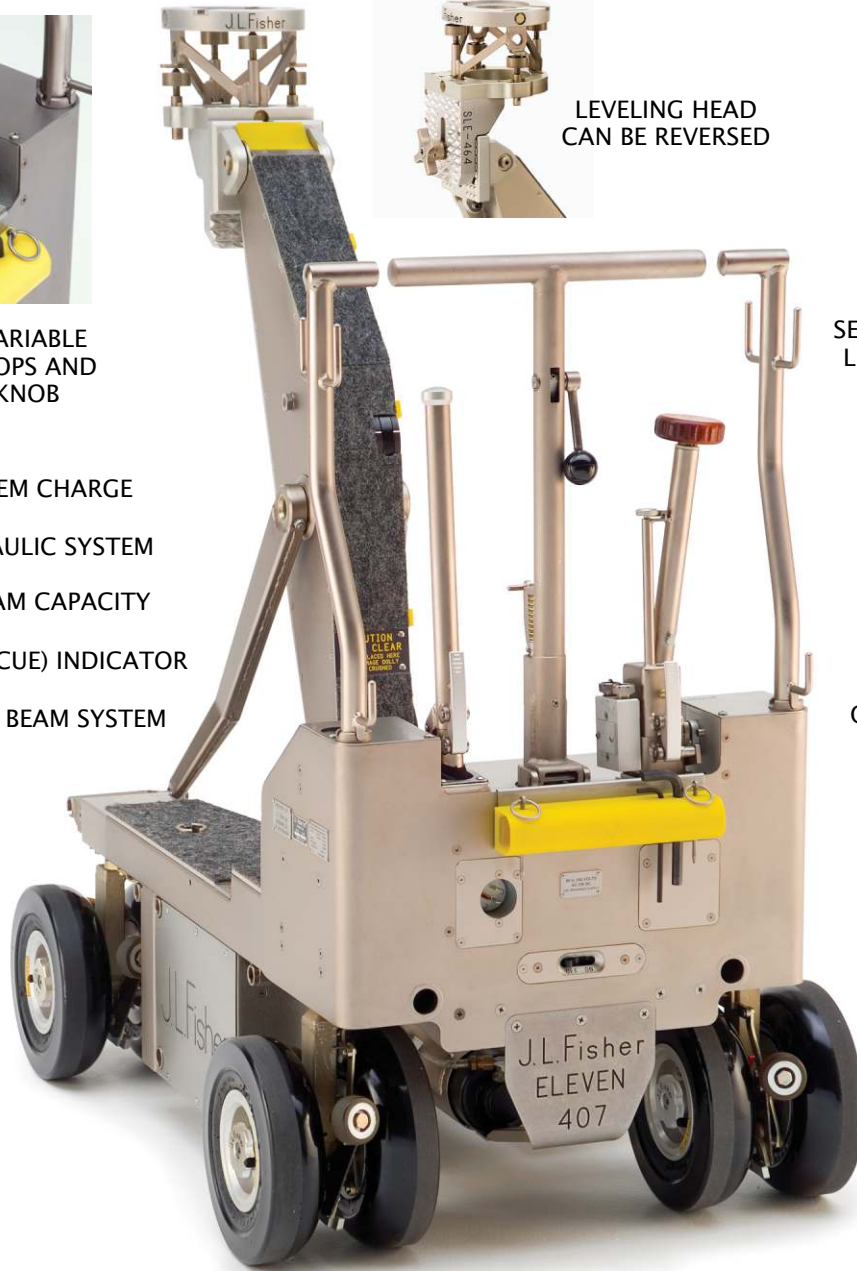

PNEUMATIC TIRES

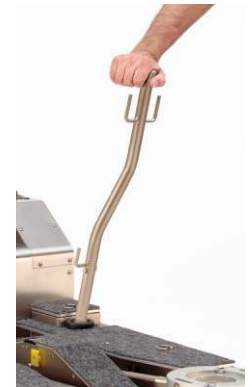

HYDRAULIC HAND PUMP FOR LOCATION WORK

The Model 11 Dolly has a maximum load capacity of 900 lbs. (408 kg)



LIFT BEAM (CUE) INDICATOR



Power Requirements:  
90 TO 240 VOLTS AC OR DC

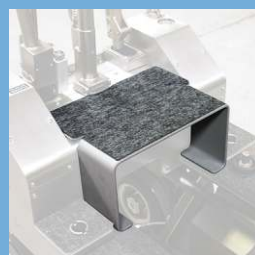

UTILITY TRAY (UTE)



FOLDING CONTROLS

### STANDARD RENTAL PACKAGE

The Standard Rental Package includes these items:

- 1 SLE 4-way Level Head
- 1 HS Hand Screw (for SLE)
- 1 ST Small Seat
- 1 S Large Seat
- 2 PP Push Posts
- 2 LE Low Side Boards
- 2 FE Front Boards
- 2 HE High Side Boards
- 2 CH Carry Handles
- 1 PC Power Cord
- 2 FPIN Front Pins
- 1 BPR Knee Bumper
- 2 AWR Allen Wrenches
- 8 TSW Pneumatic Tires
- 1 BRE Battery Box

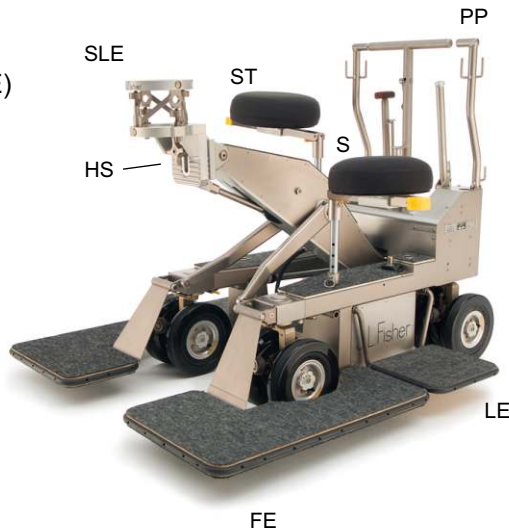

### OPTIONAL ACCESSORIES

\*Asterisk indicates items are included in the **FULL RENTAL PACKAGE**

#### Dolly Boards & Platforms

- SPE\* Standing Platform
- DEL\* Diving Board, Left
- DER\* Diving Board, Right
- EFB\* Front Board Bridge
- SFB Short Front Board
- SNFB Short Narrow Front Board
- FPE Front Porch
- RPE Front Porch Running Board (2)
- LFBE Low Front Board

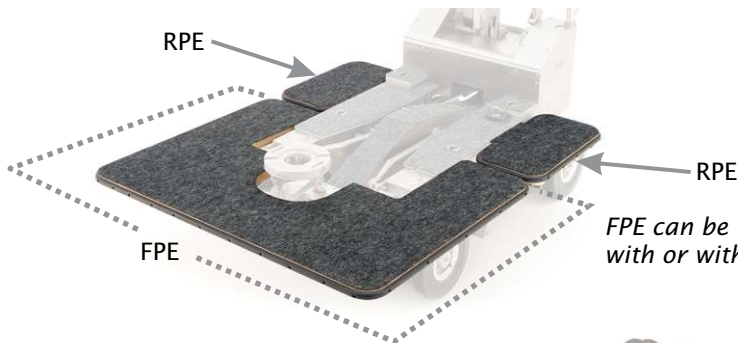

*FPE can be used with or without RPE*



#### Popular Accessories

- AC\* Accessory Carts (pair)
- PB Push Bar
- UDJ Dolly Jack (uses Push Post for handle)
- UTE Utility Tray (Eleven Dolly)

AC\* (pair)



UDJ



UTE



## MORE OPTIONAL ACCESSORIES

\*Asterisk indicates items are included in the FULL RENTAL PACKAGE

### Risers

- R3 Camera Riser, 3" (7.6cm)
- R6\* Camera Riser, 6" (15.2cm)
- R12\* Camera Riser, 12" (30.5cm)
- R6BA Camera Riser w/ 75mm Ball Adapter, 6" (15.2cm)
- R6BB Camera Riser w/ 100mm Ball Adapter, 6" (15.2cm)
- R6BC Camera Riser w/ 150mm Ball Adapter, 6" (15.2cm)
- R12BA Camera Riser w/ 75mm Ball Adapter, 12" (30.5cm)
- R12BB Camera Riser w/ 100mm Ball Adapter, 12" (30.5cm)
- R12BC Camera Riser w/ 150mm Ball Adapter, 12" (30.5cm)
- RJ6 Heavy Duty Camera Riser, 6" (15.2cm)
- RJ12 Heavy Duty Camera Riser, 12" (30.5cm)
- RJ18 Heavy Duty Camera Riser, 18" (45.7cm)



R3 R6\* R12\*



R6BA R6BB R6BC R12BA R12BB R12BC RJ6 RJ12 RJ18

### Angle Plate

- AP\* 90-Degree Camera Angle Plate

AP\*



U\*



U (Heavy Duty)



TH



TH (Heavy Duty)



### Offsets

- U\* Camera Offset, 10" (25.4cm)
- TH Camera Offset, 24" (61cm)
- RO\* Rotating Offset
- ROB Rotating Offset w/ Ball Adapter, 150mm
- ROL Rotating Offset, Low
- ROHL Rotating Offset, High/Low
- ROX Rotating Offset, Long
- ROXL Rotating Offset, Long, Low
- ROP Rotating Offset, Pivot

RO\*



ROB



ROL



ROX



ROHL



ROXL



ROP



### Adapters

- 75A 75mm Ball Adapter
- 100A 100mm Ball Adapter
- 150A 150mm Ball Adapter
- UA Universal Adapter
- HBA Half-Ball Adapter
- MEA Mitchell Euro Adapter
- ESLE Euro Boss Adapter

75A



100A



150A



UA



HBA



MEA



ESLE



### Low Level Head

- LHE\* 4-way Low Level Head
- LHA Low Head Adapter

LHE\*



LHA



### Seat & Seat Accessories

- RS Rotating Seat
- SOH\* Seat Offset High
- SOS Seat Offset Straight
- SSOS Seat Offset Short
- SR6\* Seat Riser Adjustable

RS



SOH\*



SOS



SSOS



SR6\*



## MORE OPTIONAL ACCESSORIES

### Jib Arms

- JIB20\* Model 20 Jib Arm, 51.5" (131cm) Reach  
 JIB21\* Model 21 Jib Arm, 68.5" (174cm) Reach  
 JIB22\* Model 22 Jib Arm, 99.5" (253cm) Reach



JIB21

Please refer to the Jib Arm Brochure or our web site, [www.jlfisher.com](http://www.jlfisher.com), for full specifications and options available

\* Note: Model 20, 21 and 22 Jib Arms require the use of the Center Mount (CM) and RJ12 Heavy Duty Riser on the Model 11 Dolly

### Crossarms

- CRA1 Crossarm, 11.5" (29cm) to 19" (48cm) Reach  
 CRA2 Crossarm, 15" (38cm) to 24" (61cm) Reach  
 CRA3 Crossarm, 18" (46cm) to 29" (74cm) Reach  
 CRA4 Crossarm, 23" (58cm) to 36" (91cm) Reach  
 CRA6 Crossarm, 31" (79cm) to 53" (135cm) Reach



CRA4

Please refer to the Crossarm Brochure or our web site, [www.jlfisher.com](http://www.jlfisher.com), for full specifications and options available

### Fluid Heads

- WS2 Weaver/Steadman Fluid Head, 2 Axis  
 WS3 Weaver/Steadman Fluid Head, 3 Axis  
 V Vector 700 Fluid Head, 2 Axis



WS2

WS3

V

### Other Accessories

- BAZ Bazooka (Pneumatic or Sectional)  
 CHE Short Carry Handles  
 CM Center Mount with RJ12 Riser  
 CB Cue Board  
 HH High Hat  
 LA Lamp Adapter  
 MLA Mitchell Lamp Adapter, Junior 1 1/8 in.

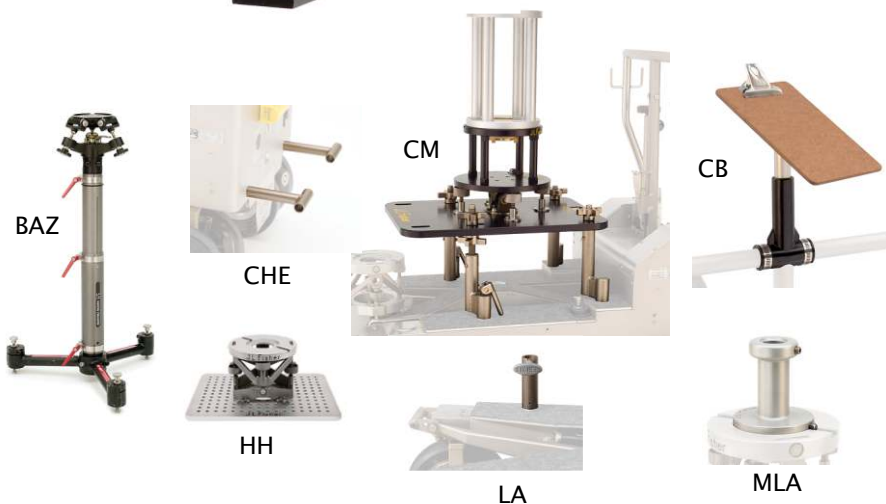

BAZ

CHE

CM

CB

HH

LA

MLA

- SCOA Scooter Board with Articulating Wheels
- 4-sets Articulating Wheels
  - Mitchell Mount
  - 4-Tie downs
  - 4-Speed rail receivers
  - 4-Carrying handles
  - 44-3/8" pre drilled holes for high hats and other accessories
  - 3-Tripod foot locators
  - 34 1/2" W x 53" L



SCOA



SCOA and SBWS  
 All 32 wheels maintain contact on both straight and curved round track.

### Wheels & Ice Skates

- SHW Shaved Wheel  
 SKE Ice Skates  
 ETW\* Round Track Wheels with Positive Locking Brakes  
 SCWE Soft Compound Wheels  
 SWE Soft Wheels  
 SBWS Skateboard Wheels  
 DSBC Dexter Skateboard Wheels

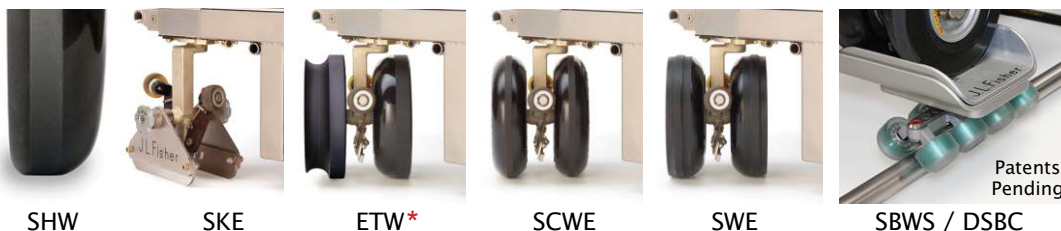

SHW

SKE

ETW\*

SCWE

SWE

SBWS / DSBC

\* ETW Wheels NOT recommended for use on CR10 (10' diameter Round Track). Skateboard Wheels SBWS recommended instead.

**Track & Track Accessories**

Straight Track sections fold from 24.5" wide to 5" wide for easy transport and storage

**Straight Track**

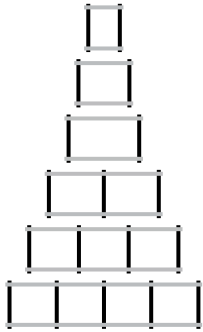

	Length	Length (folded)	Weight
<b>TR2</b>	2' (.61m)	4.1' (1.3m)	11.8 lbs (5.4kg)
<b>TR3</b>	3' (.91m)	5.1' (1.6m)	15.0 lbs (6.8kg)
<b>TR4</b>	4' (1.2m)	6.1' (1.9m)	16.2 lbs (7.3kg)
<b>TR6</b>	6' (1.8m)	8.1' (2.5m)	23.8 lbs (10.8kg)
<b>TR</b>	8' (2.4m)	10.1' (3.0m)	30.2 lbs (13.7kg)
<b>TR10</b>	10' (3m)	12.1' (3.7m)	38.0 lbs (17.2kg)

**Round Tube Track 1.5" (3.8cm) Diameter**

All J.L. Fisher track is on 24.5" (62.23cm) center line between rails.

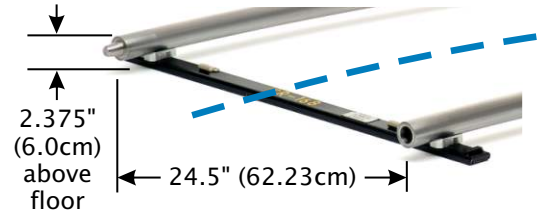

Curved Track Diameters are Measured from Centerline Between Rails

Square tube dolly track, not shown here, is available in similar sizes and diameters as the round tube track. Please call J.L. Fisher for sizes and availability.



**TS** Track Support



**Curved Track**

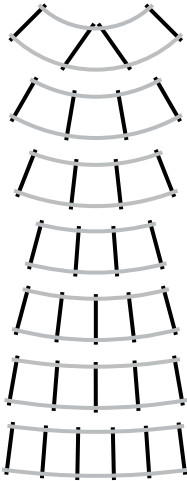

	Diameter Full Circle	Angle Section	Sections For Full Circle	Length* Section	Width* Section	Weight Section
<b>CR10</b>	10' (3m)	90°	4	8.7 ft (2.7m)	3.2 ft (.96m)	31.2 lbs (14.2kg)
<b>CR15</b>	15' (4.6m)	60°	6	8.5 ft (2.6m)	3.1 ft (.94m)	30.5 lbs (13.8kg)
<b>CR</b>	20' (6.1m)	45°	8	7.8 ft (2.4m)	3.0 ft (.91m)	29.0 lbs (13.2kg)
<b>CR25</b>	25' (7.6m)	30°	12	7.1 ft (2.2m)	2.8 ft (.85m)	27.8 lbs (12.6kg)
<b>CR30</b>	30' (9.1m)	30°	12	8.4 ft (2.6m)	2.9 ft (.88m)	33.8 lbs (15.3kg)
<b>CR50</b>	50' (15.2m)	20°	18	9.2 ft (2.8m)	2.8 ft (.85m)	34.5 lbs (15.6kg)
<b>CR70</b>	70' (21.3m)	15°	24	9.5 ft (2.9m)	2.8 ft (.85m)	38.8 lbs (17.6kg)

\* Example

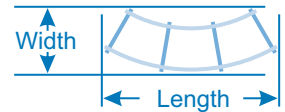

**RMPR** Track Ramp For Round Track  
**WED** Track Wedges  
**TB** Track Buckle

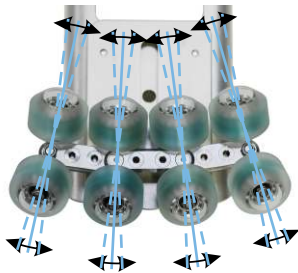

EACH SET OF 2 WHEELS (TRUCK) CAN SWIVEL INDEPENDENTLY



Model 11 Dolly shown using Built-in Track Guides on Square Curved Track (CS2)



NEW SKATEBOARD WHEELS (SBWS) (Patents Pending) come with extensions to allow the Model 11 Dolly to be mounted sideways on the wheel frame. Shown here with the extensions in place, the LOW HEAD ADAPTER (LHA) and the LOW LEVEL HEAD (LHE) on Round Straight Track (TR10)



TRACK WHEELS (ETW) ON ROUND TRACK (TR)



BUILT-IN TRACK GUIDES ON SQUARE TRACK (STR)



Maximum Lift Beam Elevation .....	51.25 in. (130 cm)
Minimum Elevation (standard head).....	13.875 in. (35 cm)
Minimum Elevation (low level head).....	3 in. (8 cm)
Vertical Beam Travel .....	33.375 in. (85 cm)
Lift Beam Capacity .....	200 pounds (90.72 kg)
Lifts per System Charge.....	7
Length .....	40 in. (102 cm)
Width (wheels in) .....	20.5 in. (52 cm)
Width (wheels out) .....	25.625 in. (65 cm)
Height (operating).....	39.75 in. (101 cm)
Height (folded) .....	23.5 in. (60 cm)
Height (center mount, before riser) .....	36.75 in. (93 cm)
Minimum Turn Radius (round steering) .....	16.188 in. (41 cm)
Minimum Turn Radius (conventional steering).....	33.5 in. (85 cm)
Maximum Dolly Load Capacity.....	900 pounds (408.23 kg)
Battery Box (BRE) inside dimensions .....	10 in. (25.4 cm) W x 7 in. (17.8 cm) H x 6.75 in. (17.1 cm) D
Carrying Weight .....	316 pounds (143.33 kg)
Crated Size .....	59 in. (150 cm) L x 31 in. (79 cm) W x 34 in. (86 cm) H
Crated Weight .....	775 pounds (351.5 kg) (standard package)

**DIMENSIONS**

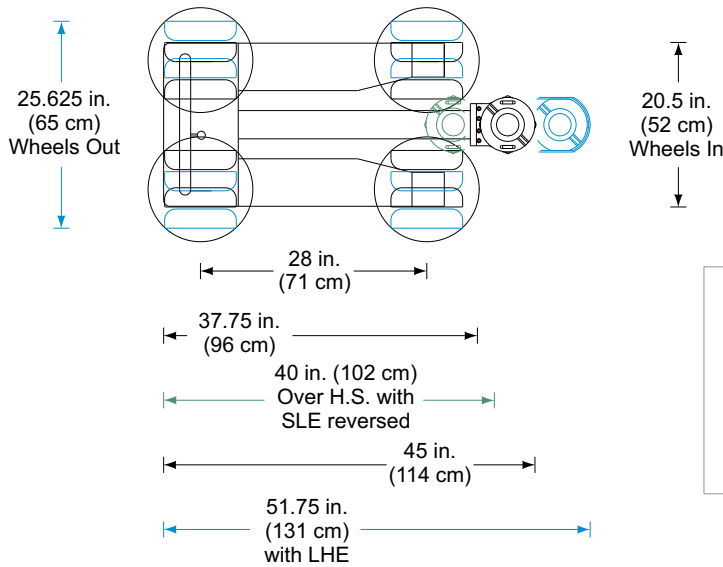

*Note: Due to variables such as adjustments and choice of risers, wheels, etc., these dimensions are approximate.*

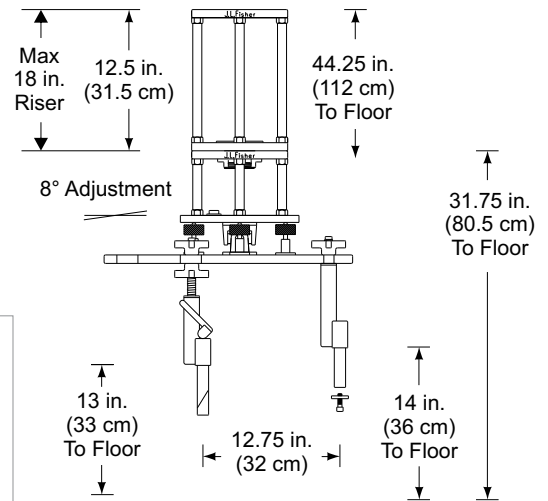

**CENTER MOUNT (CM)**

The Center Mount (CM), supports jib arms, lightweight camera booms and counterbalanced camera cranes. The Center Mount has thumbscrews for four-way leveling adjustment and a leveling indicator. Easily installed, the Center Mount has a standard Mitchell mount and comes with a heavy duty 12-inch Riser (RJ12).

The maximum gross load capacity of the Model 11 Dolly is 900 pounds (408 kg). Center Mount is not for supporting personnel or personnel carrying cranes.

**MODEL 11 DOLLY**

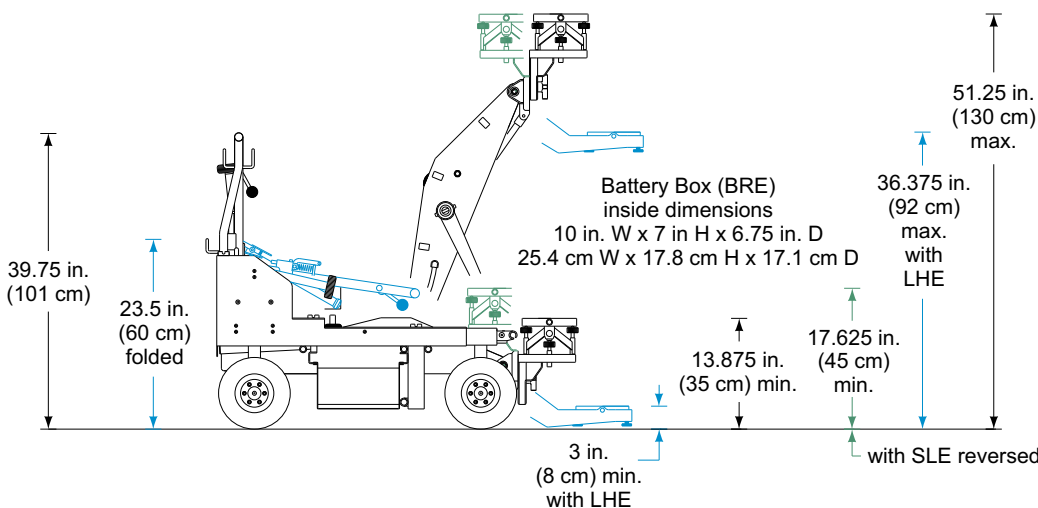

**FOLDING CONTROLS**

**J.L. FISHER PRODUCTS ARE PROUDLY MADE IN BURBANK, CALIFORNIA U.S.A.**

**J.L. Fisher, Inc. Motion Picture & Television Equipment**  
 1000 W. Isabel Street, Burbank, CA 91506 U.S.A.  
 Tel: (818) 846-8366 / Fax: (818) 846-8699  
 Web: www.jlfisher.com e-mail: info@jlfisher.com

**J.L. Fisher, GmbH Emil-Hoffmann-Str. 55-59 50996 Köln, Germany**  
 Tel: +49 2236 3922 0 Fax: +49 2236 3922 12  
 Web: www.jlfisher.de e-mail: info@jlfisher.de